



GENERAC[®]

PWRcell 2 SERIES

Product Guide

For reference only, not for construction.

Installers responsible for code compliance. Refer to product manuals for installation details and requirements.

Why Generac?



U.S.-BASED



65 YEAR HISTORY



8,000 GLOBAL EMPLOYEES



2.5 MILLION BACKUP POWER CUSTOMERS

True Energy Independence

Generac's ecosystem of residential energy solutions is unmatched in today's market. No other company offers such a wide range of complimentary products. With solutions ranging from solar batteries to home standby generators, Generac provides the ultimate flexibility for designing a comprehensive system that meets the unique needs of each homeowner.

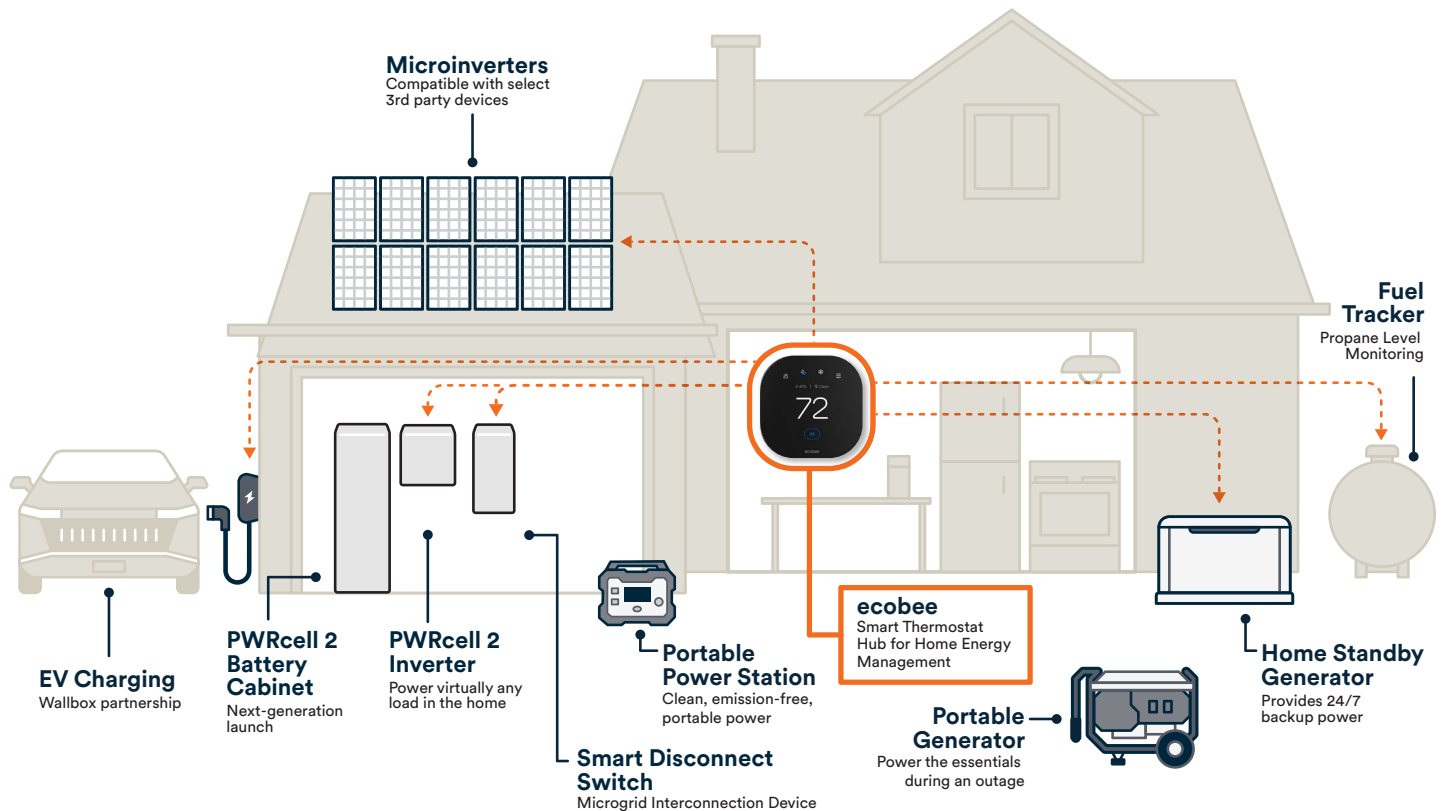



PWRcell 2 SERIES



Powerful

- Power the whole home during an outage, including multiple air conditioners, without a soft starter
- Uninterrupted switchover with a smart disconnect switch
- Expandable up to
 - » 19.2 kW AC-coupled PV
 - » 23 kW continuous power*
 - » 72 kWh battery storage*



Resilient

- Provides 33% longer back up power than industry leaders with up to 18 kWh in a single cabinet
- Fewer single points of failure with AC-coupled architecture
- Extended outage protection when paired with a Generac generator up to 26 kW



Smart

- Integration with an ecobee smart thermostat provides an easily accessible in-home display for outage details and battery status
- Automatic temperature adjustments with ecobee optimize energy consumption and extend backup duration
- Real-time monitoring from anywhere via the PWRview app

**When configured with (2) inverters and (4) M6 battery cabinets.*



Generac Home Energy Ecosystem



PWRcell 2 Battery Cabinet

- Accommodates 9 – 18 kWh in 3 kWh module increments.
- Wall or floor mount
- Pair 2 cabinets with a single inverter for up to 36 kWh
- Heated for operating in ambient temperatures as low as 23 F



PWRcell 2 Inverter

- Up to 11.5 kW max continuous power
- Up to 236 LRA motor start for multiple A/C units
- Up to 42 kVA peak power
- Fanless, silent operation



Smart Disconnect Switch (SDS)

- Bumpless switchover to battery backup
- Expandable up to 19.2 kW PV, up to 23 kW battery backup,* 26 kW home stand-by generator
- Seamless home standby generator integration with grid interlock
- Wi-Fi, LTE connectivity



Home Standby Generators

- Integration with PWRcell via SDS provides up to 26 kW of additional power
- Ultimate peace of mind with virtually endless backup subject to fuel availability



ecobee Smart Thermostat

- Provides a convenient and accessible in-home display for viewing outage details and battery status
- Automatic temperature setpoint adjustments optimize energy consumption day-to-day and extend backup duration during an outage

*When configured with (2) inverters and (4) M6 battery cabinets.

Next Generation Home Energy Storage

PWRcell 2

Power Virtually Any Home

AVAILABLE Q4 2024

PERFORMANCE					
	M3	M4	M5	M6	M6 x2
Usable Energy (kWh)	9 kWh	12 kWh	15 kWh	18 kWh	36 kWh
Max. Continuous Power (kW)	5.1 kW	6.9 kW	8.6 kW	10.3 kW	11.5 kW
Peak Inrush Power (kVA)	15 kVA	19 kVA	24 kVA	29 kVA	42 kVA
A/C Start Capacity (LRA)	76 A	102 A	127 A	153 A	236 A
Roundrip Efficiency	88%				



PWRcell 2 MAX

Most Powerful Home Battery

AVAILABLE H2 2025

PERFORMANCE					
	M3	M4	M5	M6	M6 x2
Usable Energy	9 kWh	12 kWh	15 kWh	18 kWh	36 kWh
Max. Continuous Power	9.1 kW	11.5 kW	11.5 kW	11.5 kW	11.5 kW
Peak Inrush Power	15 kVA	21 kVA	26 kVA	31 kVA	42 kVA
A/C Start Capacity (LRA)	118 A	158 A	197 A	236 A	236 A
Roundrip Efficiency	91%				

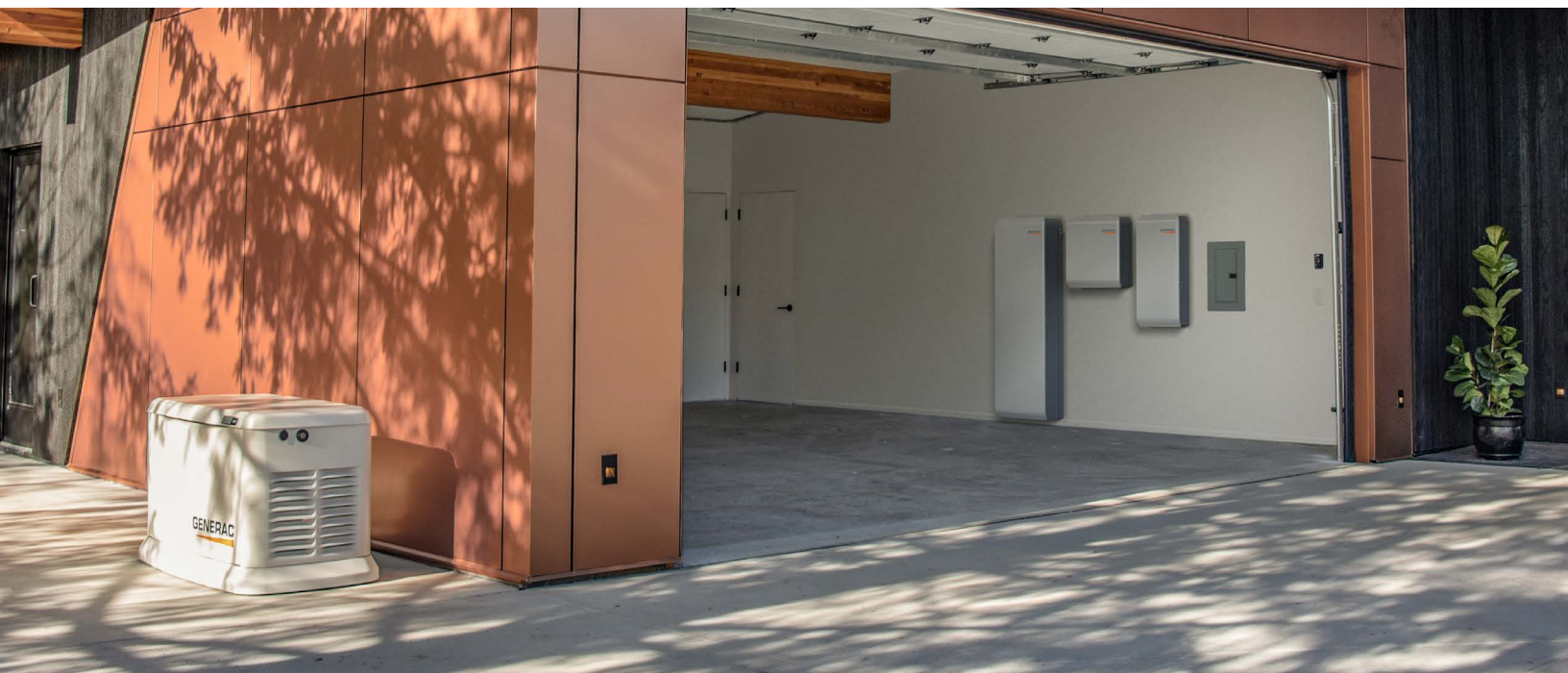

CONFIGURATIONS

Whole Home Backup

Whole Home, Single Cabinet

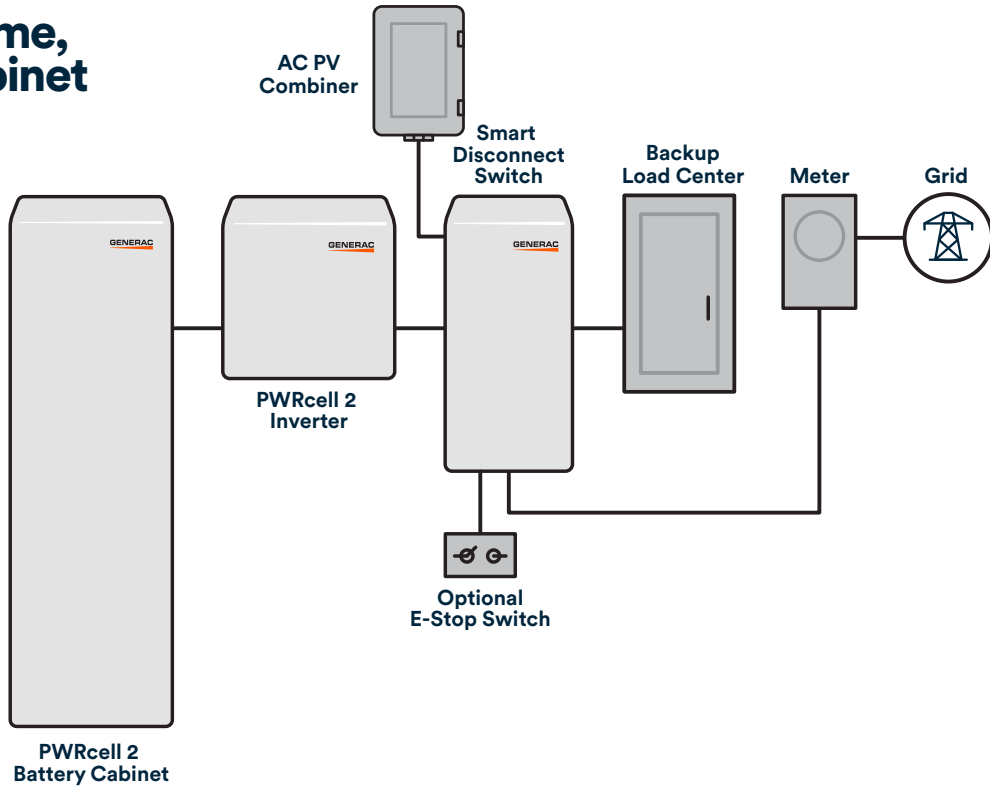

Whole Home, Dual Cabinet

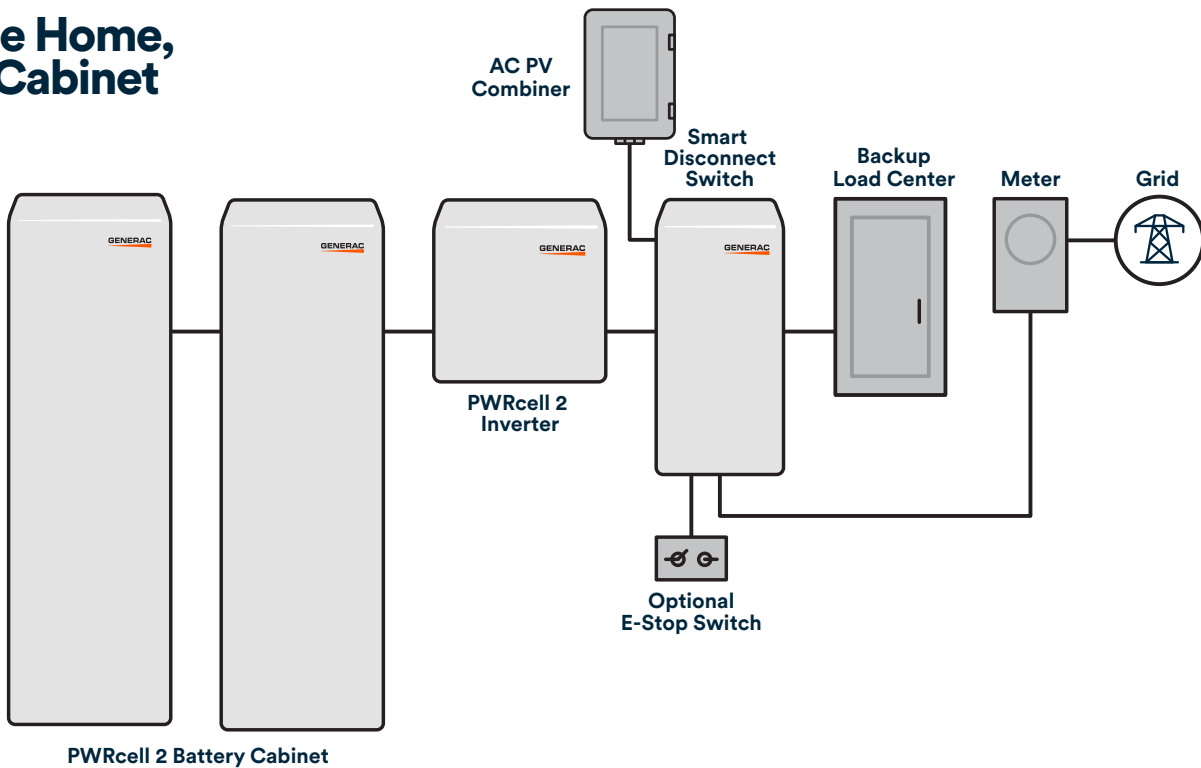

CONFIGURATIONS

Partial Home Backup

Partial Home, Typical Service

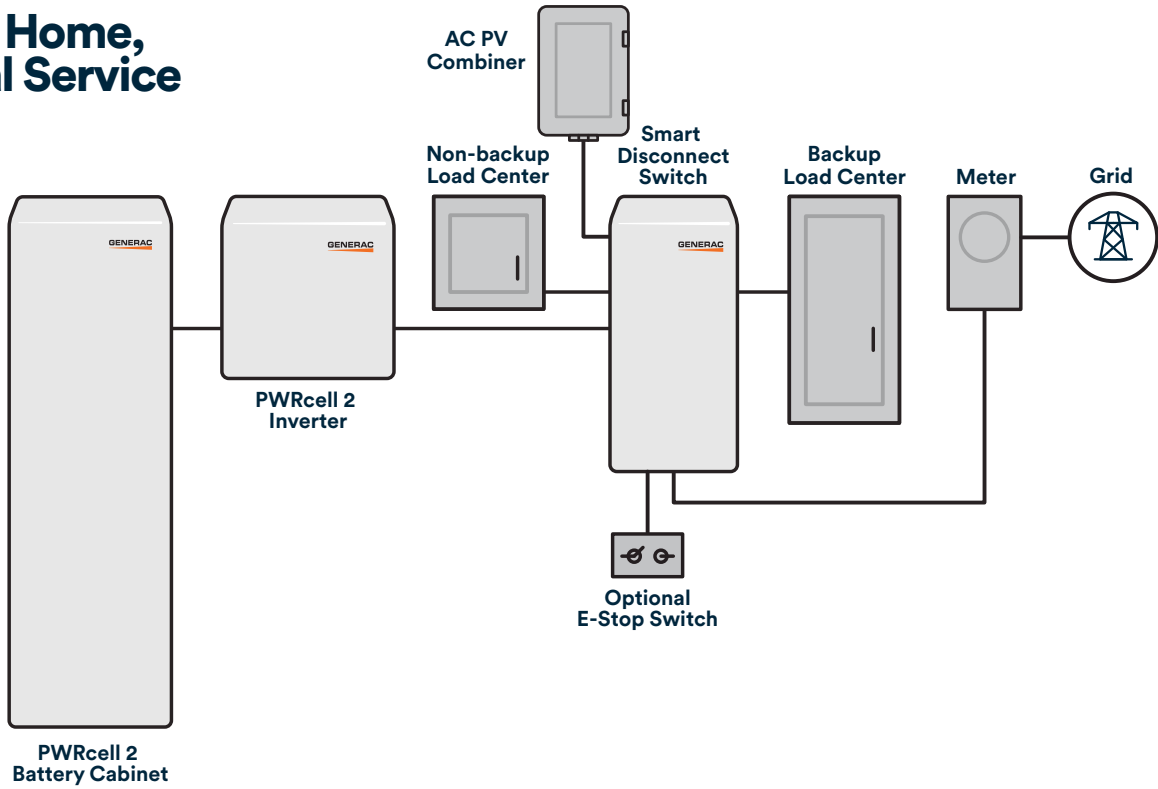

Partial Home, Meter-Main

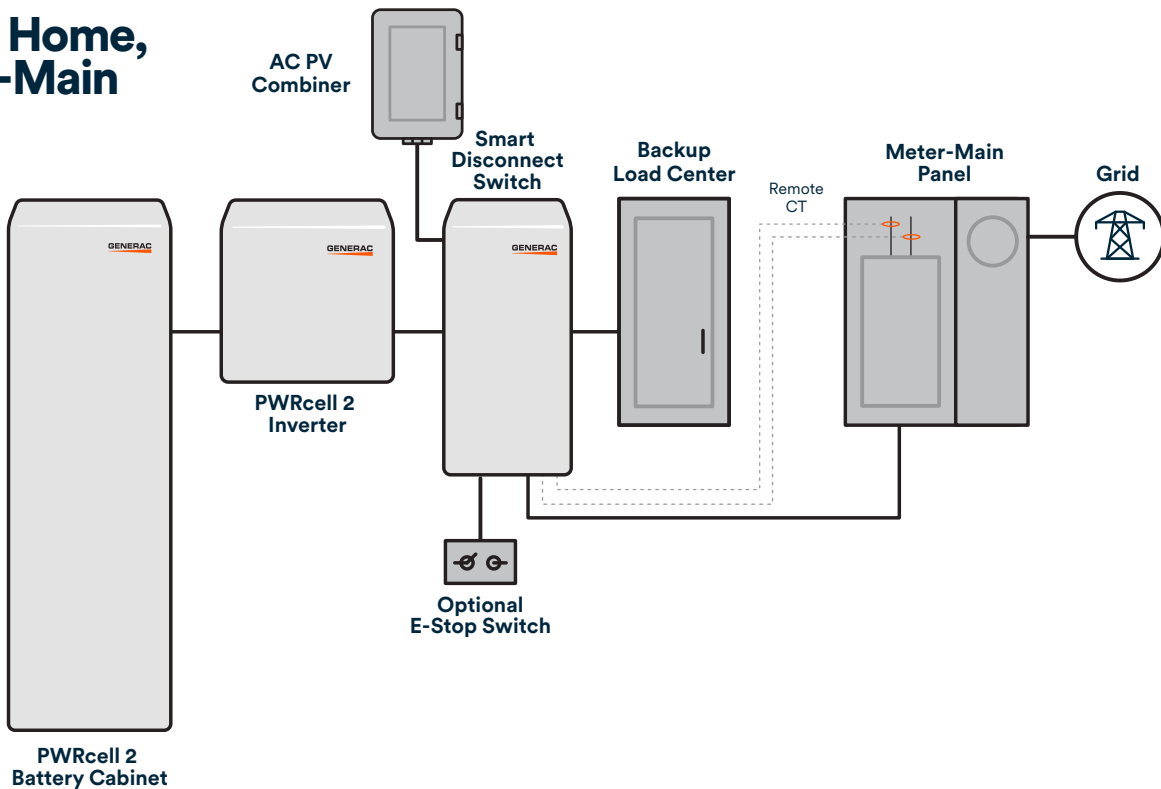

CONFIGURATION

Generator Integration

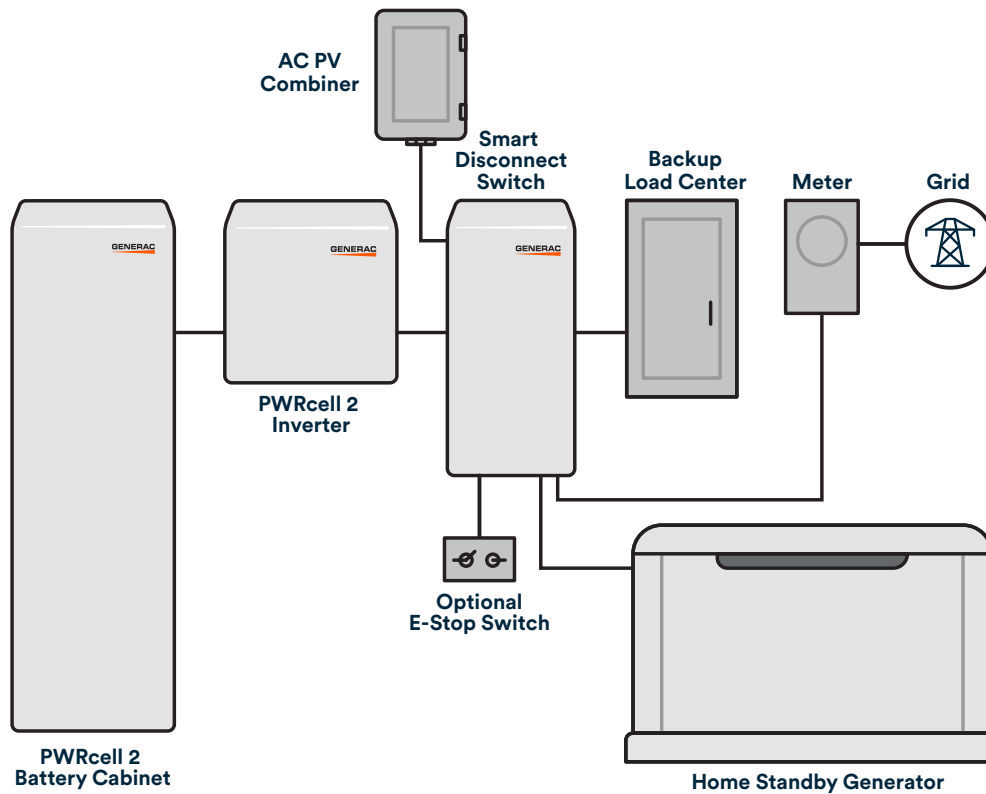

Questions?

Clean Energy Inside Sales Team

855-635-5186, Option 1 | pwrcell.sales@generac.com

Clean Energy Installer Resources

<https://www.generac.com/ceinstaller>

Product Spec Sheets and Manuals

<https://www.generac.com/dealers-installers/solar-battery-installer-support/manuals-spec-sheets/>

GENERAC[®]

Generac Power Systems, Inc.
S45 W29290 Hwy. 59, Waukesha, WI 53189

www.Generac.com | 888-GENERAC (436-3722)

201910281 | 09/2024

©2024 Generac Power Systems. All rights reserved.
Specifications are subject to change without notice.